

ORBIT[®] Installation, Operation and Maintenance

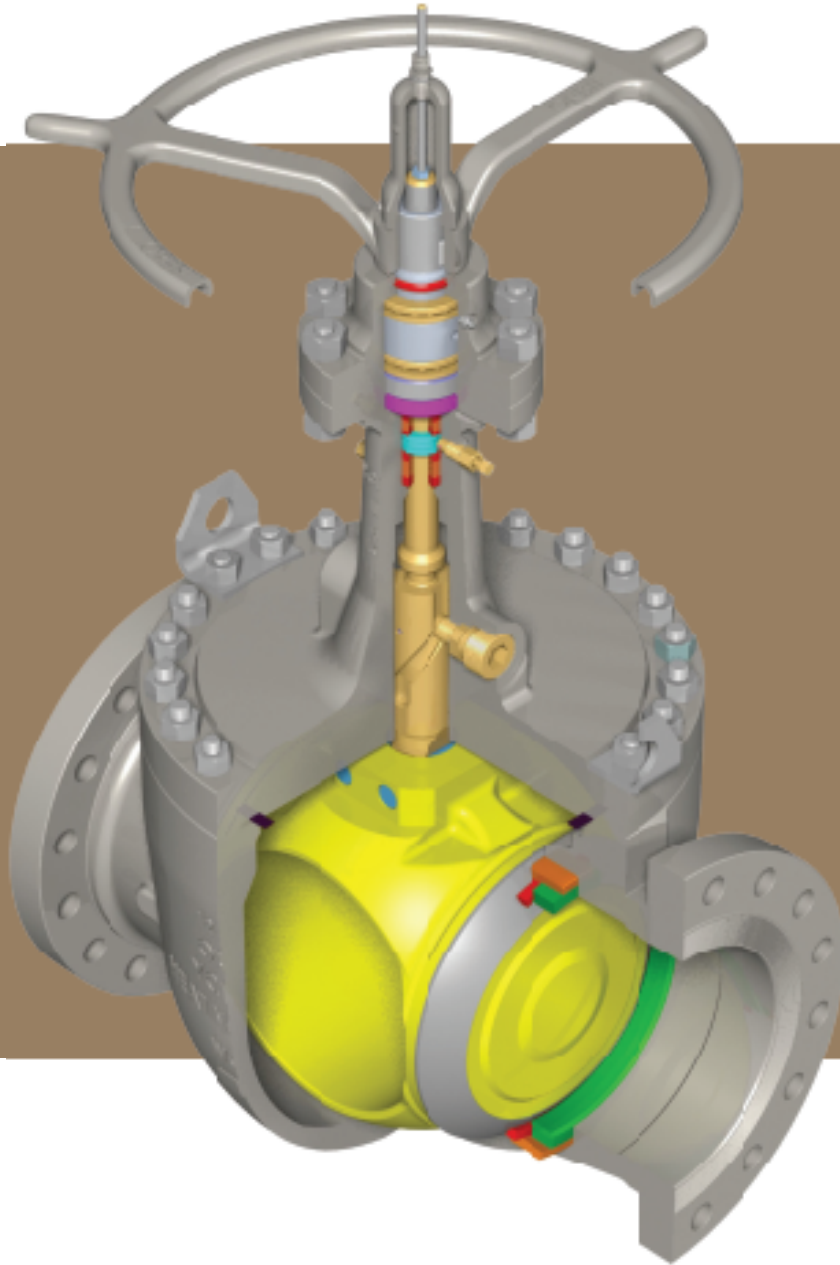

ORBIT[®]

INSTALLATION, OPERATION AND MAINTENANCE INTRODUCTION

To achieve maximum performance and to prolong equipment life, it is important to have correct installation and proper maintenance.

ORBIT Valves and Actuators are designed to require a minimum amount of maintenance.

Lubrication isn't necessary to effect a seal, only to reduce friction and wear on moving parts.

An effective lubrication program should be established from experience with the valve for its particular application and frequency of operation.

ORBIT's recommended lubrication schedule should be used as a minimum guideline.

All ORBIT Valves are equipped with an adjustable stem packing chamber which is required only if a stem leak should develop.

BEFORE YOU BEGIN

This manual outlines the correct methods for proper installation and maintenance of ORBIT Valves and Actuators.

Step by step procedures should be followed closely to prevent damage to the valves (and/or actuators) or injury to personnel.

WARNING

Valves are pressure containing vessels which can be dangerous if not handled correctly.

DO NOT REMOVE ANYTHING ON THE VALVE OR ACTUATOR UNLESS SPECIFICALLY INSTRUCTED TO DO SO IN THIS MANUAL, OR WITHOUT FIRST CONSULTING AN ORBIT REPRESENTATIVE.

FAILURE TO DO SO COULD RESULT IN INJURY TO PERSONNEL AND DAMAGE TO VALVE, ACTUATOR AND PROPERTY.

OTHER LITERATURE AVAILABLE

This manual covers only installation, operation and maintenance of ORBIT Valves and Actuators.

Other information includes:

VALVE REPAIR

ACTUATOR REPAIR

ACTUATOR SIZING GUIDE

PRODUCT INFORMATION

TECHNICAL CATALOG

Consult your ORBIT Representative for additional information on ORBIT Valves and Actuators.

TABLE OF CONTENTS

ORBIT INSTALLATION, OPERATION AND MAINTENANCE

Pre-Installation Inspection	2
Installation of Manually Operated Valves	3
Installation of Actuated Valves	5

REFERENCE DATA

Figure Number Codes	8
Position Indicator Reference Chart	8
End Flange Bolting Dimensions	9
Groove Numbers for Ring Type Joint (RG/RTJ) Flanges	10
Valve Illustrations Showing Lube Points	11

LUBRICATION

Lubrication Schedule and Recommended Lubricants	12
Valve and Actuator Lubrication	12

STEM PACKING ADJUSTMENT

Stem Packing Adjustment	15
Stem Packing Materials	17

DRILLING VALVES

Installation, Lubrication and Stem Packing Adjustment	17
---	----

TRADEMARK INFORMATION	18
------------------------------------	----

ADDITIONAL ORBIT INFORMATION

The ORBIT Valve	
Technical Reference Data for Valves and Actuators	
Dimensional Data for Valves and Actuators	
Automated Valve Packages	
Standard Instrumentation Packages for ORBIT Pneumatic Actuators	
Parts List and Ordering Instructions	

INSTALLATION, OPERATION AND MAINTENANCE PRE-INSTALLATION INSPECTION

1 The first step is to check the valve nameplate for size, class and trim. Size and class are also marked on the body.



5 On handwheel valves, cycle fully open and fully closed to check for ease of operation. Check indicator rod travel against dimensions on page 8 to verify full stem travel.



2 Verify that the valve is suitable for the service in which it is being installed by referring to the service tag and nameplate.

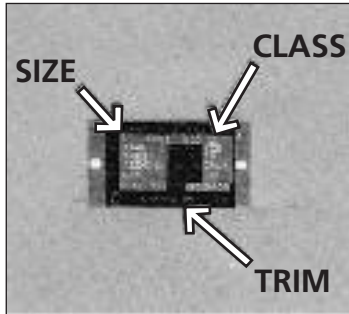

6 For valves equipped with power actuators, verify that a proper air supply or electric power source is available.



3 Check the handwheel and position indicator rod for possible damage.



7 For actuated valves equipped with an instrument package, verify that all components and piping are undamaged.



4 On flanged valves, remove the flange protectors and inspect the flange facings for deep nicks and scratches.

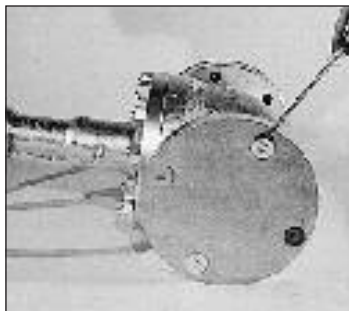

8 After these points have been checked and approved, the valve is ready for installation.



INSTALLATION, OPERATION AND MAINTENANCE

INSTALLATION OF MANUALLY OPERATED VALVES

1 Small valves (as shown at right) may be lifted or carried by the handwheel without damage to the valve.



5 This will provide longer valve life and easier operation.



2 Larger valves should be lifted by using the lifting lugs provided, or by looping a chain around bonnet as shown at right.



6 The words preferred pressure end have been abbreviated to "Pref. Pres. End" and can be found stamped on one end connection. This stamping is marked with red paint.



3 Never lift larger valves by the handwheel. Attempts to lift a large or heavy valve in this fashion can result in injury to personnel and damage to valve and property.

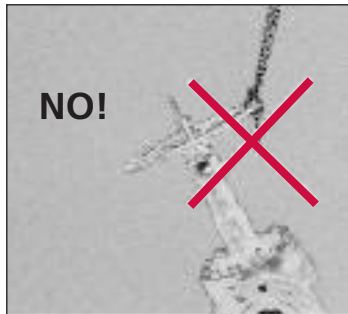

7 When possible, ORBIT valves should be installed with the bonnet in a vertical position. When repairs are necessary, consult your ORBIT representative for details on how to repair an ORBIT valve without removing it from the line.

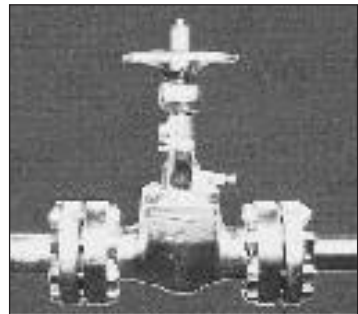

4 During installation, orient the valve so that the preferred pressure end will be toward the higher pressure, when the valve is closed.



8 ORBIT flanged valves can be bolted into the line using standard studs and nuts. See pages 9 and 10 for more information.

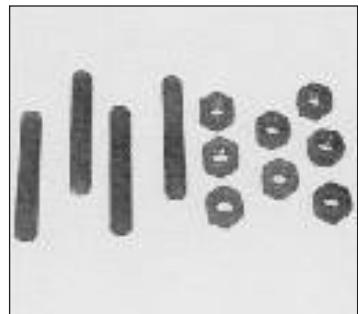

INSTALLATION, OPERATION AND MAINTENANCE

INSTALLATION OF MANUALLY OPERATED VALVES (CONTINUED FROM PREVIOUS PAGE)

9 ORBIT Block-and-Bleed, or grease seal valves are threaded for a fitting, but are shipped with a pipe plug to prevent damage to the valve and/or fitting. The pipe plug should now be removed and replaced with the proper fitting.



13 Securely tighten with a pipe wrench. For safety, threaded piping requires secure anchoring of all components that are screwed into threaded valves.



10 On threaded valves, inspect the threads in both ends of the valve to verify no damage occurred during shipment. Be sure there is no dirt, grit, or chips in the valve bore or threads.

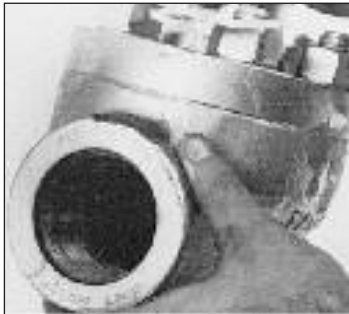

14 For weld end valves the temperature required to weld the valve into the line will exceed the rated working temperature of the valve. ORBIT valves with Nylon or Teflon seats are vulnerable to damage by excessive heat, so use the following precautions.



15 Close the valve before welding to protect the seat and core face.



11 Apply a quality thread compound to the threads on the pipe.

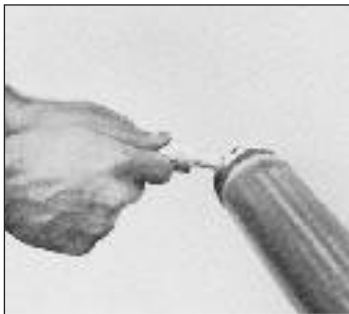

16 We recommend the size of the weld rod never exceeds 5/32 in. (4.0 mm) diameter and the maximum body temperature does not exceed the valve rating during welding.

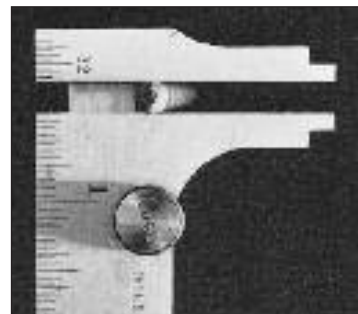

12 Carefully align the pipe and valve threads and thread the valve clockwise on the pipe.



17 When insulating low temperature valves, do not insulate above this line. Insulating above this line can result in injury to personnel and damage to valve and property.



INSTALLATION, OPERATION AND MAINTENANCE

INSTALLATION OF ACTUATED VALVES

1 ORBIT automated packages are equipped with lifting eyes. These should be used during installation to prevent damage to the unit and avoid injury to personnel.



5 The words preferred pressure end have been abbreviated to "Pref. Pres. End" and are stamped on one end connection. It is marked with red paint for easy identification.



2 For valves equipped with actuators not manufactured by ORBIT, use lifting eyes if present. Otherwise, loop a chain around the valve bonnet to lift the unit.



6 On piston actuated valves, a gas over oil tank is provided to assure smooth operation and prevent valve damage.

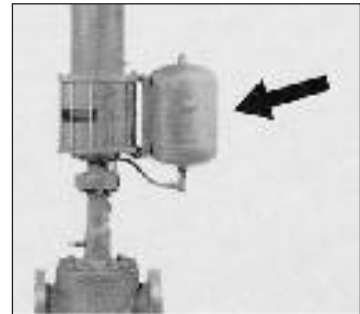

3 During installation orient the valve so that the preferred pressure end will be toward the higher pressure when the valve is closed.

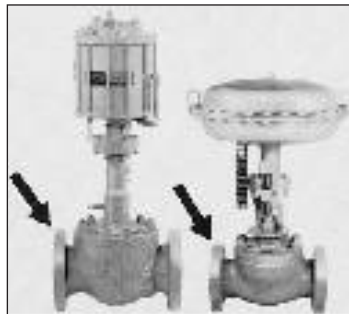

7 The gas over oil tank must be in the vertical position when the valve is installed. Unless otherwise specified at the time of order, the gas over oil tank will be mounted in this position.

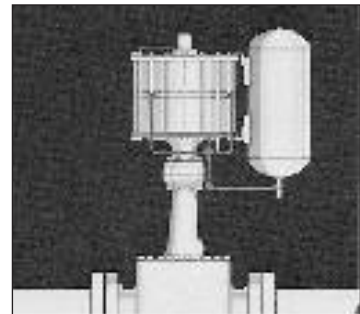

4 This is important because it reduces wear and because the valve may be rated at a different working pressure when installed in the opposite direction.

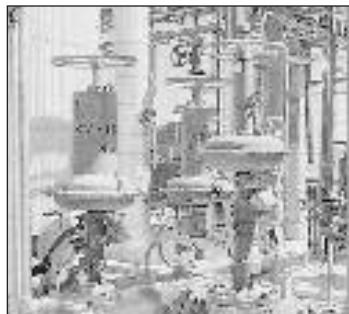

8 If your valve and actuator package is to be installed with the stem in other positions, the gas over oil tank must be mounted vertically. For example, in a horizontal piping run. Depending on valve and actuator combination, bracing may be required to support actuator.

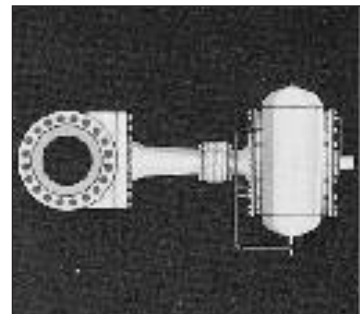

INSTALLATION, OPERATION AND MAINTENANCE

INSTALLATION OF ACTUATED VALVES (CONTINUED FROM PREVIOUS PAGE)

9 Or in a vertical run. Depending on the valve and actuator combination, bracing may be needed to support the actuator.

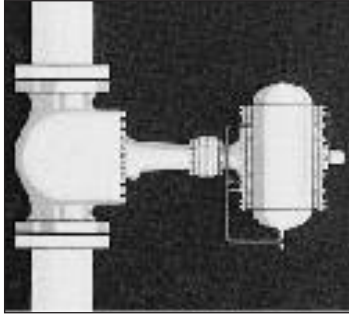

13 Unless otherwise specified on the nameplate, the minimum actuator pressure should always be within 5 psi, 0.3 bar of maximum pressure.



10 ORBIT valves and actuators can be installed in the line using standard studs, nuts and gaskets. See pages 9 and 10 for more information.

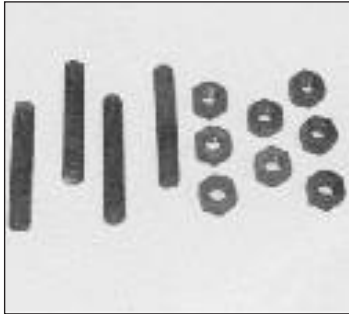

14 Connect the opening air supply for the diaphragm actuator to the bottom point A. Connect the closing air supply to the top point B.

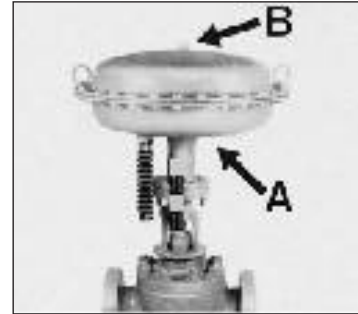

11 After the valve and actuator unit has been installed in the line, the actuator power supply should be connected.

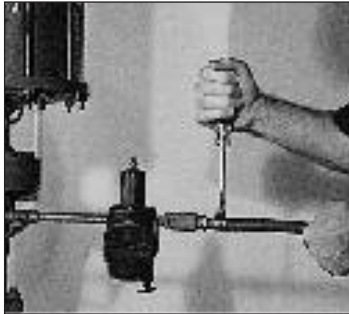

15 The first step in installing an ORBIT Piston Actuated Valve is to check the **NAMEPLATE** to determine if the actuator is the LG type or the LS type. LG or LS will be the first letters of the actuator figure number. For example, LS-124-D-3-X-S.



12 IMPORTANT! For pneumatic actuators manufactured by ORBIT, the supply pressure must be regulated to the amount shown on the nameplate. Failure to comply with this can damage the unit.



16 If the nameplate is illegible do not attempt to install without consulting an ORBIT Representative.



INSTALLATION, OPERATION AND MAINTENANCE

INSTALLATION OF ACTUATED VALVES (CONTINUED FROM PREVIOUS PAGE)

17 On LG type double acting piston actuators, the closing air supply is connected to point A and the opening air supply is connected to the top of the gas over oil tank point B.

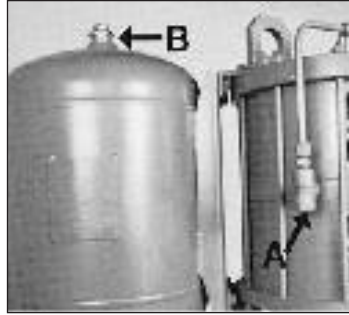

21 Also on LS spring close piston actuators the pipe plug on top of the gas over oil tank must be replaced with the filter breather supplied. Failure to do this could keep the unit from operating and result in injury to personnel and damage to valve, actuator and property.



18 For LG type spring close piston actuators the opening air supply is connected to the top of the gas over oil tank point B. On loss of air supply, the actuator closes forcing the oil into the tank.

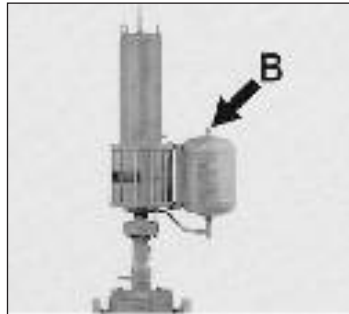

22 Most piston actuators except those equipped with a hydraulic open mechanism will be the LS model. The Double Acting piston with a hydraulic open model will continue to be the LG type.



19 The LS type piston actuator is a new design that reduces the size of the gas over oil tank and allows quicker operating times. The opening air supply is connected at point A and the closing air supply is connected to the top of the gas over oil tank point B.

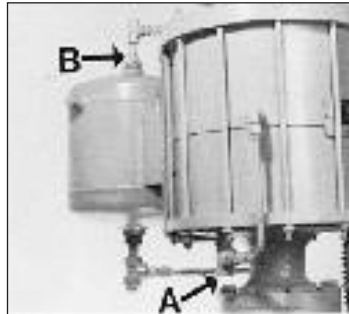

23 Cycle the valve fully open and fully closed to verify correct operation. Check the indicator rod for full travel. Rod travel distance can be found on page 8. Check the instrumentation for correct operation.



20 For LS type spring close piston actuator the opening air supply is at point A. Failure to connect the opening air supply to this point will keep the actuator from opening the valve.



24 The valve and actuator package is now ready for operation.



INSTALLATION, OPERATION AND MAINTENANCE

ORBIT FIGURE NUMBER CODES

ORBIT VALVE			STANDARD TRIM	
LITTLE ROCK, ARK				
SIZE	3" 900 CL		END TO END 15"	
FIG	1523H RF		1995 MOP AT +500F	
	SN 110091620001		2250 MOP AT -20F	
PKG	GP6		STEM AS	
SEAT	CR13 TEF		BODY STEEL WCC	
MFG	6D-0073		CORE TRIM 17-4	
DATE	04/01 ISO 14313		CORE FACE NI	
IMPACTTEMP -50F			TEMP -20/+500F	

MODEL

1. Carbon Steel Valves (API 6D or ASME B16.34)
2. Carbon Steel and Low Alloy
3. Low Alloy Steel Valves (WC6, WC9, C5)
4. API Wellhead Valves
5. British Gas Council
6. Corrosive 316 SS (-100°F)
7. Duplex Stainless Steel
8. Drilling Valves
9. High Alloy (Monel, Hastelloy, Inconel, 6MO)

CLASS

CLASS	PN
1. ASME 150	20
2. ASME 300	50
4. ASME 600	64
5. ASME 900	100
6. ASME 1500	250
7. ASME 2500	420
3. API 1000	-
5. API 2000	-
6. API 3000	-
7. API 5000	-

PORT SIZE & CONNECTION

2. Full Port, Flanged and Hub End
3. Reduced Port, Flanged and Hub End
4. Full Port, Threaded
5. Reduced Port, Butt Weld and Socket Weld
6. Full Port, Butt Weld
6. Full Port, Socket Weld
6. Full Port, Butt Weld x RF
7. Full Port, Special
8. Reduced Port, Special

TRIM*

0. T3 Modified
2. T7 Modified
3. Standard (T3)
5. Special Preparation
7. Sour Corrosive (T7)
8. Low Temp./Corrosive (316 SS) (T8)

SUFFIX**

- A, H, H8 - Type of Seat
- L - Adapted for Actuator
- BB - Block and Bleed Model
- GS - Grease Seal Model
- S - Non-Standard End to End Dimension

* For a more complete explanation of trims and figure numbers, consult your ORBIT Representative.
 ** Valve figure numbers may use more than one suffix. Example: 1423H8L.

POSITION INDICATOR REFERENCE CHART

On an ORBIT Actuator or an ORBIT Valve with a rising stem valve position indicator, the indicator rod shows valve position. To determine if a valve, or valve and actuator package is achieving full travel, measure the protruding portion of the indicator rod in the closed position. Cycle the valve and measure the indicator rod in the open position. Subtract to find valve travel.

VALVE SIZE		ASME CLASS	NOMINAL TRAVEL	
in.	mm		in.	mm
1	25	150-2500	1 1/8	29
1 1/2	40	150-600	1 1/2	38
1 1/2	40	900-1500	1 3/4	44
2 x 1 1/2 x 2	50 x 40 x 50	150-600	1 1/2	38
2, 3 x 2 x 3	50, 80 x 50 x 80	150-600	1 1/2	38
2, 3 x 2 x 3	50, 80 x 50 x 80	900-1500	1 3/4	44
2, 3 x 1 13/16 x 3	50, 80 x 46 x 80	2500	1 3/4	44
3, 4 x 3 x 4	80, 100 x 80 x 100	150-300	1 1/2	38
3, 4 x 3 x 4	80, 100 x 80 x 100	600	1 3/4	44
3, 4 x 3 x 4	80, 100 x 80 x 100	900-1500	2 1/4	57
3, 4 x 3 x 4	80, 100 x 80 x 100	2500	2 1/4	57
4, 6 x 4 x 6	100, 150 x 100 x 150	150-300	1 3/4	44
4, 6 x 4 x 6	100, 150 x 100 x 150	600-900	2 1/4	57
4, 6 x 4 x 6	100, 150 x 100 x 150	1500	2 15/32	63
4, 6 x 4 x 6	100, 150 x 100 x 150	2500	2 3/8	60
6, 8 x 6 x 8	150, 200 x 150 x 200	150-300	2 15/32	63
6, 8 x 6 x 8	150, 200 x 150 x 200	600	2 7/8	73
6, 8 x 6 x 8	150, 200 x 150 x 200	900	3 1/4	83
6, 8 x 6 x 8	150, 200 x 150 x 200	1500	3 5/8	92
6, 8 x 6 x 8	150, 200 x 150 x 200	2500	3 3/4	95
8, 10 x 8 x 10	200, 250 x 200 x 250	150-300	2 7/8	73
8, 10 x 8 x 10	200, 250 x 200 x 250	600	3 1/4	83
8, 10 x 8 x 10	200, 250 x 200 x 250	900	4 1/4	108
8, 10 x 8 x 10	200, 250 x 200 x 250	1500	7 1/2	191
8, 10 x 8 x 10	200, 250 x 200 x 250	2500	8 15/16	227
10, 12 x 10 x 12	250, 300 x 250 x 300	150-300	3 1/4	83
10, 12 x 10 x 12	250, 300 x 250 x 300	600	4 1/4	108
10, 12 x 10 x 12	250, 300 x 250 x 300	900	4 3/8	111
10, 12 x 10 x 12	250, 300 x 250 x 300	1500	8 15/16	227
12, 14 x 12 x 14	300, 350 x 300 x 350	150-300	4 1/4	108
12, 14 x 12 x 14	300, 350 x 300 x 350	600	4 11/16	119
12, 14 x 12 x 14	300, 350 x 300 x 350	900	5 3/8	137
12, 14 x 12 x 14	300, 350 x 300 x 350	1500	10 7/8	276
14	350	300	4 1/4	108
16	400	900	10 7/8	276
16, 18 x 16 x 18	400, 450 x 400 x 450	150-600	5 9/16	141
16, 20 x 16 x 20	400, 500 x 400 x 500	150-600	5 9/16	141
18	450	150	5 7/8	150
20, 24 x 20 x 24	500, 600 x 500 x 600	300-900	10 7/8	275

INSTALLATION, OPERATION AND MAINTENANCE END FLANGE BOLTING DIMENSIONS

Valve Size in.	ASME/ANSI CLASS 150				CLASS 300				CLASS 600				
	Number of Fasteners Per Valve	Fastener Diameter in.	Length of Studs in.	*Length of Capscrews in.	Number of Fasteners Per Valve	Fastener Diameter in.	Length of Studs in.	*Length of Capscrews in.	Number of Fasteners Per Valve	Fastener Diameter in.	Length of Stud RF in.	Length of Stud RTJ in.	*Length of Capscrew in.
1	8	1/2	3	-	8	5/8	3 1/4	-	8	5/8	3 1/2	3 1/2	-
1 1/2	8	1/2	3 1/4	-	8	3/4	3 1/2	-	8	3/4	4 1/4	4 1/4	-
2 x 1 1/2 x 2	8	5/8	3 1/4	-	16	5/8	3 1/2	-	16	5/8	4 1/4	4 1/4	-
2	8	5/8	3 1/4	-	16	5/8	3 1/2	-	16	5/8	4 1/4	4 1/4	-
2 BB/GS	8	5/8	3 1/4	-	-	-	-	-	-	-	-	-	-
3 x 2 x 3	8	5/8	3 1/2	-	16	3/4	4 1/4	-	16	3/4	5	5	-
3*	8	5/8	2 1/2	1 1/2	16	3/4	4 1/4	-	16	3/4	5	5	-
4 x 3 x 4*	16	5/8	2 3/4	1 3/4	16	3/4	4 1/2	-	16	7/8	5 3/4	5 3/4	-
4*	16	5/8	2 3/4	1 3/4	12	3/4	4 1/2	-	16	7/8	5 3/4	5 3/4	-
	-	-	-	-	4	3/4	-	2 1/4	-	-	-	-	-
6 x 4 x 6	16	3/4	4	-	24	3/4	4 3/4	-	24	1	6 3/4	6 3/4	-
6*	16	3/4	3	2	16	3/4	4 3/4	-	24	1	6 3/4	6 3/4	-
	-	-	-	-	8	3/4	-	2 1/2	-	-	-	-	-
8 x 6 x 8	16	3/4	4 1/4	-	24	7/8	5 1/2	-	24	1 1/8	7 1/2	7 3/4	-
8*	12	3/4	4 1/4	1 1/2	16	7/8	5 1/2	-	24	1 1/8	7 1/2	7 3/4	-
	4	3/4	-	2	8	7/8	-	3	-	-	-	-	-
10 x 8 x 10*	20	7/8	4 1/2	-	28	1	6 1/4	-	32	1 1/4	8 1/2	8 1/2	-
	4	7/8	4 1/2	2 1/4	4	1	-	3 3/4	-	-	-	-	-
10	24	7/8	4 1/2	-	32	1	6 1/4	-	32	1 1/4	8 1/2	8 1/2	-
12 x 10 x 12	24	7/8	4 3/4	-	32	1 1/8	6 3/4	-	40	1 1/4	8 3/4	8 3/4	-
12	24	7/8	4 3/4	-	32	1 1/8	6 3/4	-	40	1 1/4	8 3/4	8 3/4	-
14 x 12 x 14	24	1	5 1/4	-	40	1 1/8	7	-	40	1 3/8	9 1/4	9 1/4	-
14	-	-	-	-	40	1 1/8	7	-	40	1 3/8	9 1/4	9 1/4	-
16 x 12 x 16	-	-	-	-	-	-	-	-	40	1 1/2	10	10	-
16 x 14 x 16	32	1	5 1/4	-	40	1 1/4	7 1/2	-	-	-	-	-	-
16	32	1	5 1/4	-	40	1 1/4	7 1/2	-	40	1 1/2	10	10	-
18 x 16 x 18	32	1 1/8	5 3/4	-	48	1 1/4	7 3/4	-	40	1 5/8	10 3/4	11	-
20 x 16 x 20	40	1 1/8	6 1/4	-	48	1 1/4	8	-	48	1 5/8	11 1/4	11 1/2	-
18	32	1 1/8	6 1/4	-	-	-	-	-	-	-	-	-	-
20*	-	-	-	-	48	1 1/4	7 3/4	-	36	1 5/8	11 1/4	11 1/2	-
	-	-	-	-	-	-	-	-	12	1 5/8	-	-	5 3/4
24 x 20 x 24	-	-	-	-	48	1 1/2	9	-	48	1 7/8	13	13 1/4	-

* Space limitations prevent the use of through bolts in some of the holes in the end flanges on these valves. These holes are drilled and tapped so that a shorter stud bolt or capscrew can be used.

INSTALLATION, OPERATION AND MAINTENANCE

END FLANGE BOLTING DIMENSION (CONTINUED FROM PREVIOUS PAGE)

ASME/ANSI CLASS 900					CLASS 1500				CLASS 2500			
Valve Size in.	Number of Fasteners Per Valve	Fastener Diameter in.	Length of Studs RF in.	Length of Studs RTJ in.	Number of Fasteners Per Valve	Fastener Diameter in.	Length of Studs RF in.	Length of Studs RTJ in.	Number of Fasteners Per Valve	Fastener Diameter in.	Length of Studs RF in.	Length of Studs RTJ in.
1	8	3/4	5	5	8	7/8	5	5	-	-	-	-
1 1/2	8	1	5 1/2	5 1/2	8	1	5 1/2	5 1/2	-	-	-	-
2	16	7/8	5 3/4	5 3/4	16	7/8	5 3/4	5 3/4	16	1	7	7
3 x 2 x 3	16	7/8	5 3/4	5 3/4	16	1 1/8	7	7	16	1 1/4	9	9 1/4
3	16	7/8	5 3/4	5 3/4	16	1 1/8	7	7	16	1 1/4	9	9 1/4
4 x 3 x 4	16	1 1/8	6 3/4	6 3/4	16	1 1/4	7 3/4	7 3/4	16	1 1/2	10 1/4	10 3/4
4	16	1 1/8	6 3/4	6 3/4	16	1 1/4	7 3/4	7 3/4	16	1 1/2	10 1/4	10 3/4
6 x 4 x 6	24	1 1/8	7 1/2	7 1/2	24	1 3/8	10 1/4	10 1/2	16	2	13 3/4	14 1/2
6	24	1 1/8	7 1/2	7 1/2	24	1 3/8	10 1/4	10 1/2	16	2	13 3/4	14 1/2
8 x 6 x 8	24	1 3/8	8 3/4	8 3/4	24	1 5/8	11 1/2	12 3/4	24	2	15 1/4	16
8	24	1 3/8	8 3/4	8 3/4	24	1 5/8	11 1/2	12 3/4	24	2	15 1/4	16
10 x 8 x 10	-	-	-	-	24	1 7/8	13 1/4	13 1/2	24	2 1/2	19 1/2	20 1/2
10	32	1 3/8	9 1/4	9 1/4	24	1 7/8	13 1/4	13 1/2	-	-	-	-
12 x 10 x 12	-	-	-	-	32	2	14 3/4	15 1/4	-	-	-	-
12	40	1 3/8	10	10	32	2	14 3/4	15 1/4	-	-	-	-
14 x 12 x 14	40	1 1/2	10 3/4	11	-	-	-	-	-	-	-	-
16 x 12 x 16	-	-	-	-	32	2 1/2	17 1/2	18 1/2	-	-	-	-
16 x 14 x 16	40	1 5/8	11 1/4	11 1/2	-	-	-	-	-	-	-	-

RG/RTJ GROOVE NUMBERS

Size in.	ASME/ANSI Class	Groove Numbers
1	600	R16
1 1/2	600, 900 & 1500	R20
2	600	R23
2	900 & 1500	R24
2	2500	R26
3	600 & 900	R31
3	1500	R35
3	2500	R32
4	600 & 900	R37
4	1500	R39
4	2500	R38
6	600 & 900	R45
6	1500	R46
6	2500	R47
8	600 & 900	R49
8	1500	R50
8	2500	R51
10	600 & 900	R53
10	1500	R54
12	600 & 900	R57
12	1500	R58
14	600	R61
16	600	R65
18	600	R69
20	600	R73

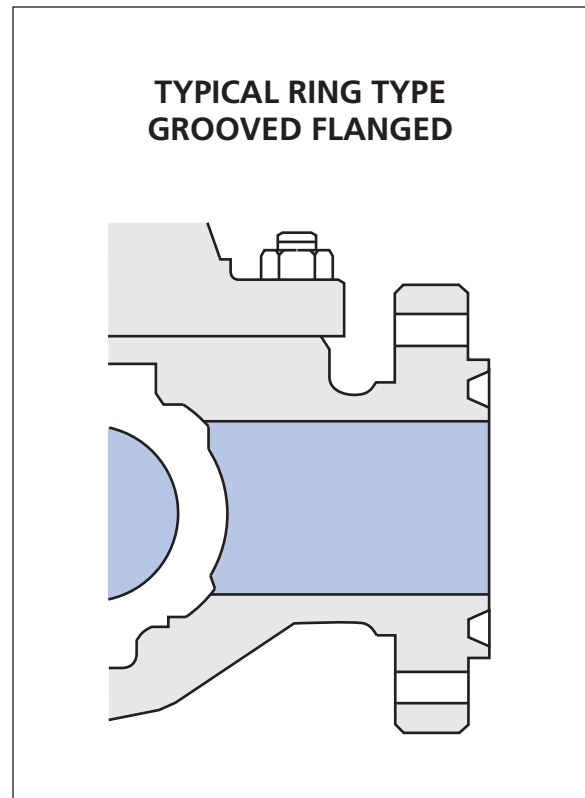

INSTALLATION, OPERATION AND MAINTENANCE

VALVES WITH ONE LUBE POINT

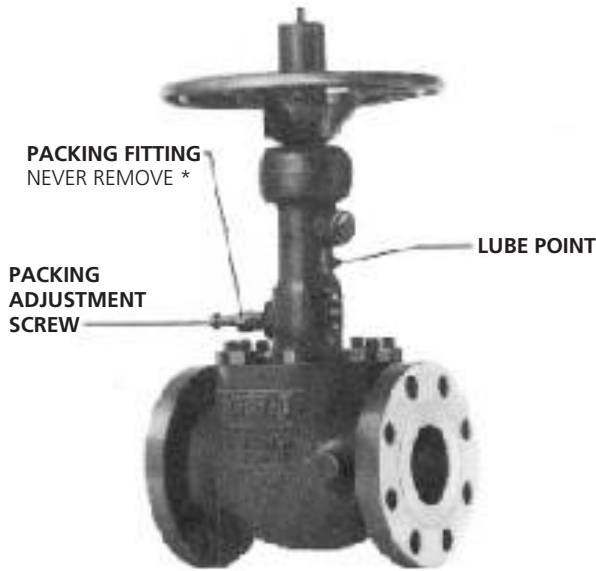

SMALL BORE STANDARD



SMALL BORE O.S.&Y.

VALVES WITH TWO LUBE POINTS

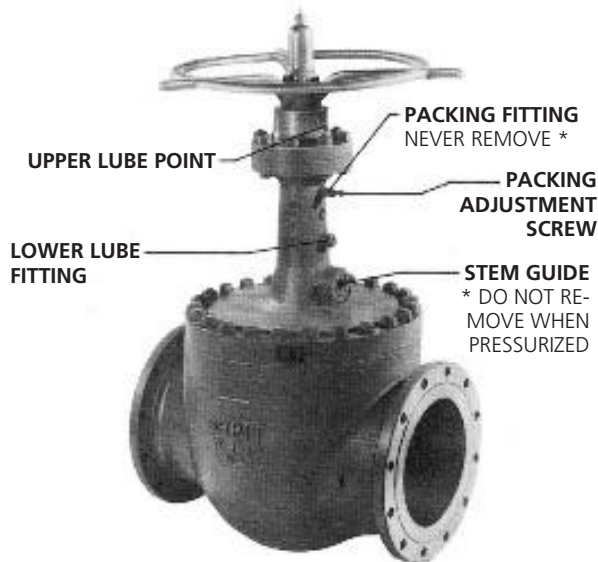

LARGE BORE STANDARD

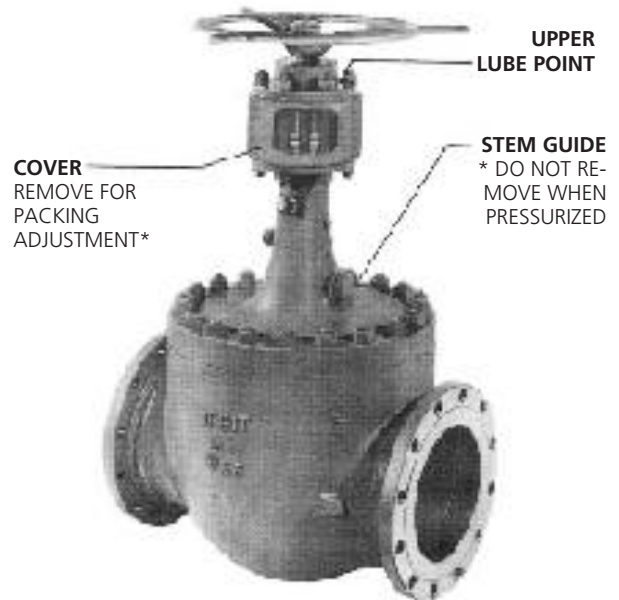

LARGE BORE O.S.&Y.

*Personal injury and/or damage to property may result. Consult your ORBIT Representative for additional information.

INSTALLATION, OPERATION AND MAINTENANCE - LUBRICATION

ORBIT RECOMMENDED LUBRICATION SCHEDULE

The frequency of valve lubrication should be based on user's past experience with installed equipment. The following schedule of lubrication should be used as a minimum guideline until operating experience indicates otherwise:

1. A minimum of once a year.
2. Every time the valve is serviced for stem leak.
3. We recommend quarterly lubrication if valve is operated infrequently (once a day or less).
4. Every 1000 cycles if valve is operated more than 10 times a day.
5. Every 500 cycles if the valve is used in corrosive or other severe services and operated more than 10 times a day.

SPECIAL SERVICE MAINTENANCE

Consult your ORBIT Representative before performing any maintenance on valves in special services such as oxygen, ethylene oxide, hydrofluoric acid and any other potentially dangerous services.

RECOMMENDED LUBRICANTS

For standard valves we recommend a high quality lithium base grease. For temperatures below -20°F (-29°C) we recommend a low temperature grease.

The typical fluid used in the gas over oil system is automotive automatic transmission fluid such as Mobil ATF 220 or equivalent.

1 ORBIT valves will give maximum performance and long life when used with an effective maintenance program.



4 The only tool required for lubrication is a grease gun with standard hydraulic type coupler. Valves equipped with a lower tube fitting or a grease seal fitting require a safe vent coupler for lubrication. This is available from ORBIT or Alemite, part #G-310428.



2 Lubrication is not used in ORBIT valves to effect a seal. It is used only to reduce friction and wear on moving parts. The only exception is the Grease Seal model which utilizes grease as a secondary sealant.



5 **WARNING!** Pressure containing areas of the valve can be dangerous if not handled properly. If valve is in service do not remove any parts unless specifically instructed to do so by an ORBIT Representative or ORBIT repair manuals.

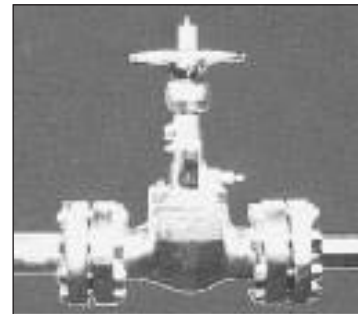

3 The recommended lubrication schedule and types of grease are shown at the top of this page.



6 All ORBIT valves are equipped with an upper lube fitting as shown. This lubricates the upper portion of the stem and the bearings. No line pressure will be encountered. Between two and ten strokes on the grease gun provides adequate lube penetration.



INSTALLATION, OPERATION AND MAINTENANCE - LUBRICATION

(CONTINUED FROM PREVIOUS PAGE)

7 All large bore ORBIT valves are also equipped with a lower lube fitting in the pressure area of the valve. This is a safe vent lube fitting.



11 ORBIT Grease Seal valves are equipped with a safe vent lube fitting in the seat area of the valve.



8 Remove the cap slowly to be sure the ball check in the fitting has sealed off the line pressure. Do not remove any parts other than this cap.

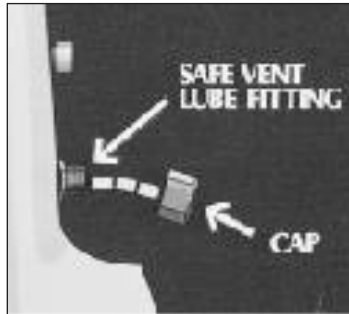

12 Lubrication is identical to steps 8 - 10 except lubricate until the leak stops.

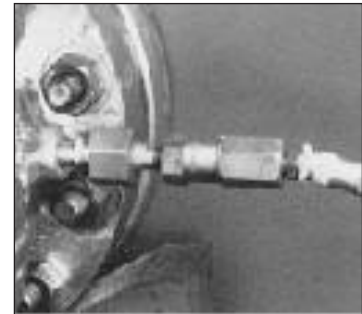

9 Thread the safe vent coupler to the lube fitting. Before attaching the grease gun be sure the output capacity is higher than the line pressure.



13 All ORBIT valves (except O.S.&Y. design) equipped with diaphragm actuators are lubricated through the upper lube point on the valve bonnet. No line pressure will be encountered. Two strokes of the grease gun provide adequate lubrication. Excess grease will make the position indicator difficult to see.

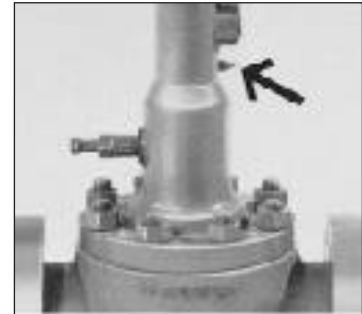

10 Two complete strokes on the grease gun provide sufficient lubrication. Cycle the valve if possible to evenly distribute the grease. Excess grease will discharge into the system piping.



14 O.S.&Y. ORBIT valves equipped with diaphragm actuators are lubricated at the lube point on the adapter sleeve* above the line pressure. Two strokes of the grease gun provide adequate lubrication. Excess grease will make the position indicator difficult to see.

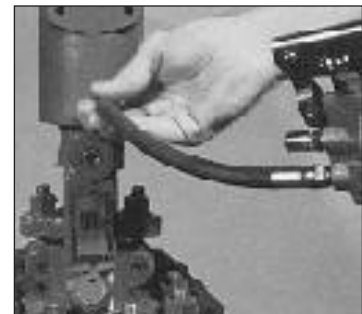

* New style ORBIT diaphragm actuators have grease fitting installed in actuator case.

(CONTINUED ON NEXT PAGE)

INSTALLATION, OPERATION AND MAINTENANCE - LUBRICATION

(CONTINUED FROM PREVIOUS PAGE)

15 ORBIT diaphragm actuators equipped with a manual close mechanism have an additional upper lube point located on the manual closer stem. Spring close diaphragm actuators have no upper lube point.



16 Diaphragm actuators equipped with a two way manual mechanism have an upper lube point that is only accessible when the manual mechanism is in the open position.

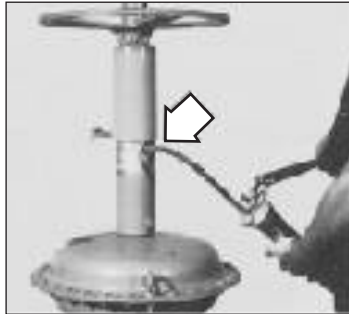

17 All ORBIT piston actuators have a lower lube point above pressure line pressure.



18 ORBIT piston actuators equipped with a manual close mechanism have an additional upper lube point, which lubricates the manual mechanism stem. Piston actuators with a two way manual mechanism have no upper lube point.



19 Piston actuators equipped with two way gear mechanism have a lube point on the gear box as shown.

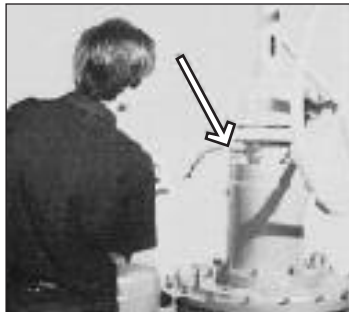

20 All ORBIT piston actuators are equipped with a gas over oil tank to assure smooth operation and prevent valve damage. Proper fluid level is important.

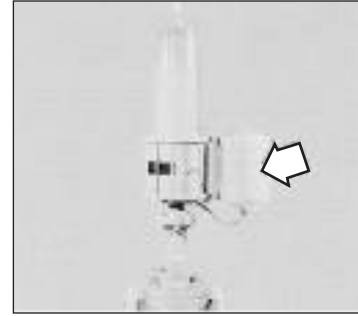

21 To check the fluid level, read the nameplate to determine if the actuator is the LG type or the LS type. If the nameplate is illegible or missing **DO NOT** attempt to check the fluid level without consulting ORBIT Representative.



22 To check fluid level for the LG type, **CLOSE** the valve. This forces the hydraulic fluid from the actuator into the gas over oil tank. In the closed position the fluid should reach the level indicated in the chart below.

WARNING! If the fill plug is removed in the OPEN position, actuator pneumatic pressure will be encountered if the system is under pressure. Personal injury and/or damage to property may result.

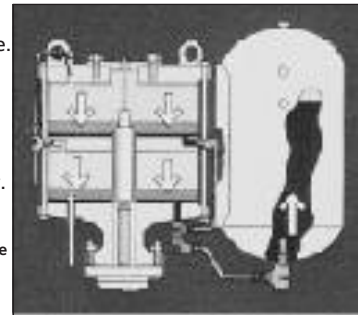

CORRECT FLUID LEVEL FOR LG TYPE PISTON

Actuator	Tank Size		Fluid Level Hole	Capacity	
	in.	mm		gallon	litre
LG-124	12 x 19	305 x 483	one only	5	19
LG-185	14 x 27	356 x 686	bottom	12	45
LG-205, 206	14 x 27	356 x 686	top	15	57
LG-206	14 x 33	356 x 838	top	18	68
LG-266	16 x 38	406 x 965	top	28	106

23 To check the fluid level for the LS type piston actuator, **OPEN** the valve. This forces the oil from above the lower piston into the gas over oil tank. The fluid should reach the fill plug level indicated in the chart below. **WARNING!** If the fill plug is removed in the CLOSED position, actuator pneumatic pressure will be encountered if the system is under pressure. Personal injury and/or damage to property may result.

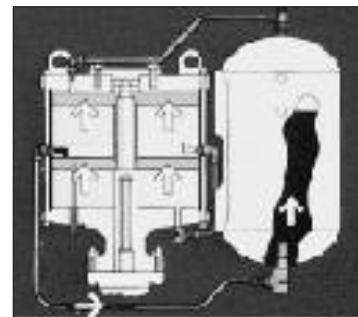

CORRECT FLUID LEVEL FOR LS TYPE PISTON

Actuator	Tank Size		Fluid Level Hole	Capacity	
	in.	mm		gallon	litre
LS-124	10 x 11 1/2	254 x 292	one only	3	11
LS-185	12 x 19	305 x 483	bottom	6	23
LS-205	12 x 19	305 x 483	top	8	30
LS-206	14 x 27	356 x 686	bottom	12	45
LS-266	14 x 27	356 x 686	top	15	57
LS-207	14 x 30	356 x 762	bottom	12	15
LS-208	14 x 30	356 x 762	top	14	53
LS-267	14 x 30	356 x 762	top	14	53
LS-269	16 x 41	406 x 1041	top	25	95

INSTALLATION, OPERATION AND MAINTENANCE STEM PACKING ADJUSTMENT

1 All ORBIT valves except O.S.&Y. bonnet design utilize a hydraulic type stem packing chamber. Stopping stem leaks promptly reduces damage to the packing and the valve.

WARNING! Do not remove packing fitting. Personal injury and/or damage to property may result.

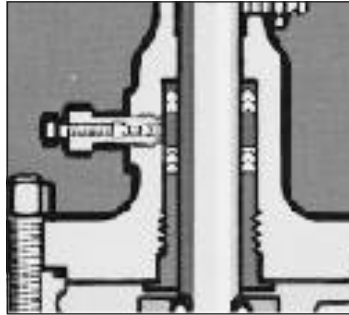

5 Should the plastic packing become depleted, it can be replaced by removing the packing adjustment screw. (This should be done slowly and carefully to be sure the ball check has sealed off the packing chamber pressure.) and replacing it with the type of plastic packing that is shown on the nameplate. Do not substitute without...

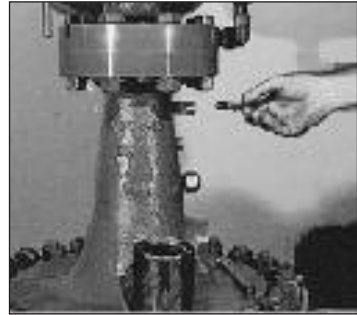

2 Stem leaks are most frequently associated with start ups or other operating changes, but some may develop during steady operation or after long use.

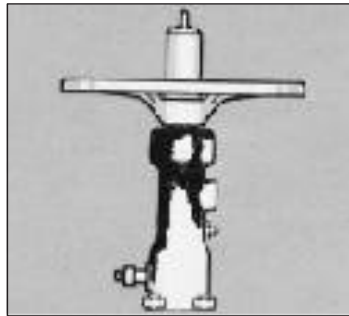

6 ...consulting the chart on page 17. Replace the adjustment screw and advance it to stop the leak but do not exceed a 50 lb. pull on a 6 in. wrench (20 kg pull on a 150 mm wrench). A sufficient number of threads in the packing chamber must be left exposed to allow engagement of the packing screw threads.



3 To stop stem leaks, advance or tighten the packing adjustment screw. This forces the plastic packing past the ball check into the packing chamber.

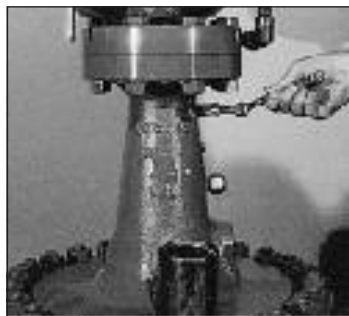

7 DO NOT OVER PACK! Over packing can result in stiff handwheel operation or can build up excessive pressure in the stem packing chamber, causing forceful expulsion of the entire packing fitting. To prevent over packing when the valve is in service, do not exceed a 50 lb. pull on a 6 in. wrench (20 kgs pull on a 150 mm wrench).



4 As the plastic packing is forced into the packing chamber it increases the pressure and reactivates the Chevron type packing rings. Usually 5 to 10 turns on the adjustment screw will stop the stem leak.

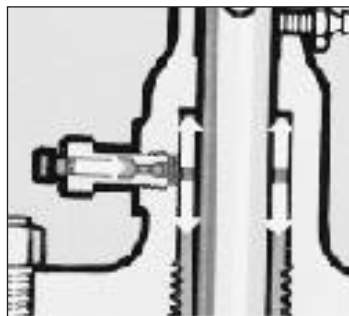

8 If the valve is not in service, partially open the valve and advance the adjustment screw until the handwheel will not coast (freewheel) after being spun. Do not exceed a 50 lb. pull on a 6 in. wrench (20 kg pull on a 150 mm wrench).



(CONTINUED ON NEXT PAGE)

INSTALLATION, OPERATION AND MAINTENANCE ADJUSTMENT (CONTINUED FROM PREVIOUS PAGE)

9 WARNING! If the valve has been over packed - DO NOT TRY TO REMOVE THE BODY OF THE PACKING FITTING to relieve the excessive packing pressure. Injury or damage could result. The packing chamber retains high pressure even if the valve is not in service.

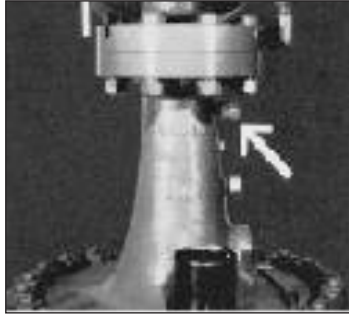

13 If a stem leak occurs, more compression can be applied by evenly adjusting the hex nuts on the gland retainer bolts. Too much compression on the retainer can cause the stem to bind, making the valve hard to operate.



10 Remove the packing adjustment screw and gently tap against the ball check with a 1/8 in. pin punch. This will allow the excessive pressure to escape past the ball check. **Wear safety glasses and gloves and stand to the side of the packing fitting centerline while relieving packing pressure.**



14 WARNING! Never completely remove the hex nuts from the gland retainer bolts while the valve is in service and under pressure. Personal injury and/or damage to property may result.



11 ORBIT high temperature valves feature an adjustable type stem packing made possible by utilizing a deep stuffing box, packing gland, and gland flange retained with adjustment bolts and nuts.

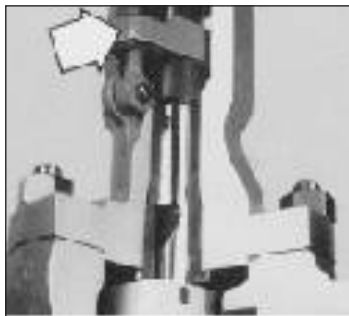

15 For the packing adjustment nuts to be accessible on large bore O.S.&Y. valves the cover must be removed.

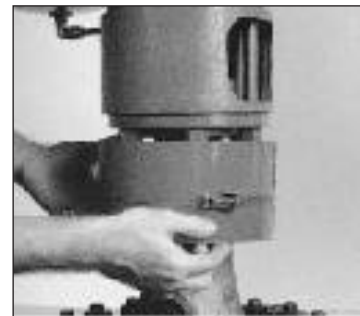

12 Effective sealing of pressure by the stem packing rings is maintained by the compression applied to the gland flange and retainer bolts.

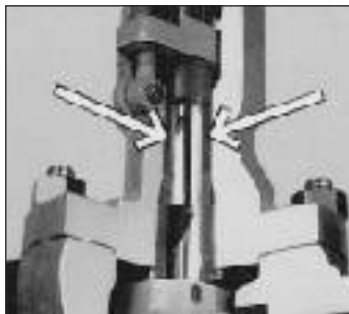

16 The stem packing will not harden up to 800°F (427°C). This packing is very effective, requires little attention and is suitable for steam, air, water, liquefied petroleum, natural gas and a variety of chemicals.

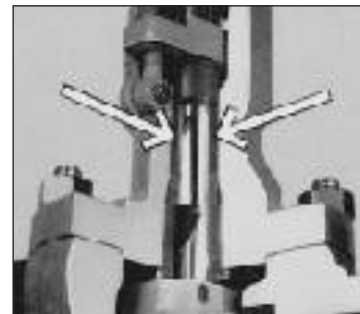

INSTALLATION, OPERATION AND MAINTENANCE STEM PACKING MATERIALS

<h3>GP-6</h3> <p>General Service</p>	<h3>GP-7</h3> <p>Oxygen and Related Service</p>	<h3>GP-19</h3> <p>Ammonia Service</p>	<h3>GP-20</h3> <p>High Temperature Graphite Rings O.S.&Y. Model</p>
<h3>GP-26</h3> <p>316 S.S. Valve</p>		<h3>GP-27</h3> <p>Unleaded Gasoline With MTBE*</p>	

RECOMMENDED REPLACEMENT FOR DISCONTINUED PACKING

Obsolete Packing	Recommended Use	Recommended Replacement	Obsolete Packing	Recommended Use	Recommended Replacement
GP-5	General Service	GP-6	GP-15	HFU Service	GP-19
GP-8	Hydrogen Fluoride Service	GP-19	GP-16	800°F Service (Rings O.S.&Y. Model Only)	GP-20
GP-9	Hydrogen Sulfide Service	GP-6	GP-17	-100°F Service	None
GP-10	-50°F Service	GP-6	GP-18	600°F Service (Injectable)	None
GP-11	Hydril Valve Stem Packing	GP-7	GP-22	600°F Service (Injectable)	None
GP-12	Halogen Style	GP-7			
GP-14	Chlorine Service	None			

*MTBE - Methyl Tertiary Butyl Ether

DRILLING VALVES

1 ORBIT Drilling Valves are designed for holding pressure in one direction only. They must be installed so that the greater amount of pressure will be applied to the preferred pressure end. Damage to valve may result if not installed properly.



2 If pressure could drop below 100 psi in the closed position, USE THE STEM LOCKING DEVICE to prevent the valve from opening. To use the Stem Locking Device, tighten the lock screw in the packing gland, which forces a brass friction plug against the valve stem.



3 The special lube fitting on top of the valve is in the valve pressure area so use these precautions:

- A Attach a grease gun with out-put higher than line pressure to the fitting.
- B Back out the shut-off-screw 2 to 3 turns **ONLY**.
- C Pump in 1 to 2 lbs., 0.5 to 1 kg., of lithium base grease, and if possible cycle the valve to evenly distribute the lubricant.
- D Tighten the shut-off screw securely before removing the pump. The stem lube point "A" use a standard hydraulic lube fitting. Pump two or three times.

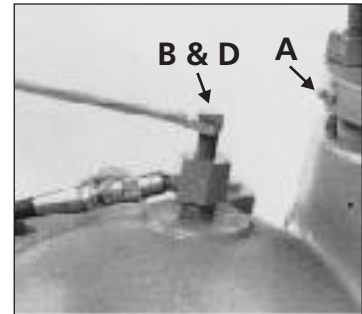

4 The conventional type Packing Gland Assembly uses braided packing rings and gland studs with nuts. Adjustment is identical to O.S.&Y. valves shown on page 16, steps 11 to 15.



TRADEMARK INFORMATION

ORBIT® is a registered trademark which is owned by Cameron.

This document contains references to registered trademarks or product designations, which are not owned by Cameron.

Trademark	Owner
CARPENTER 450	Carpenter Technology Corp.
HASTELLOY	Haynes International, Inc.
INCONEL	INCO Nickel Sales, Inc.
LATROBE	Timkin Latrobe Steel
MONEL	INCO Alloys International, Inc.
PEEK	Victrex PLC.
STELLITE	Stoody Deloro Stellite, Inc.
TEFLON	E.I. DuPont De Nemours & Company
ULTIMET	Haynes International, Inc.
VITON	E.I. DuPont De Nemours & Company

**VALVES & MEASUREMENT**

3250 Briarpark Drive, Suite 300
Houston, Texas 77042
USA Toll Free 800 323 9160

For the most current contact and location information go to: www.c-a-m.com/valvesandmeasurement